



OWNER'S GUIDE

CLASSIC WHOLE HOUSE FAN



DO NOT THROW AWAY!

SERIAL NUMBER FOR FAN IS LOCATED ON THE BACK COVER OF THE OWNER'S GUIDE.

LEAVE WITH HOMEOWNER

CONTENTS

- 1. HOW TO USE YOUR QUIETCOOL 3
 - 1.1 Introduction 3
 - 1.2 Features 3
 - 1.3 When to Run 4
 - 1.4 Where to Start Cooling 4
 - 1.5 How QuietCool Works 4
 - 1.6 Indoor Air Quality 5
 - 1.7 Winter 5
- 2. SYSTEM OVERVIEW 6
 - 2.1 Product Diagram 6
 - 2.2 System Venting Requirements 7
- GETTING STARTED - IMPORTANT - READ BEFORE INSTALL! 8**
- 3. INSTALLATION 10
 - 3.1 Installing QuietCool 10
 - 3.2 Installing Vertical Adapter 12
- 4. WIRING 13
 - 4.1 Single Speed Wiring - QC CL-1500 13
 - 4.2 Two Speed Wiring - QC CL-2250/3100/4700/5400/6000/7000 14
- 5. SYSTEM OPERATING INSTRUCTIONS 17
 - 5.1 Operating the Wall Controls 17
- WARRANTY 19
- SERIAL NUMBER BACK COVER

QC MANUFACTURING, INC.
 26040 YNEZ ROAD
 TEMECULA, CA 92591

PHONE 1-888-QUIETCOOL
WEBSITE WWW.QUIETCOOLSYSTEMS.COM

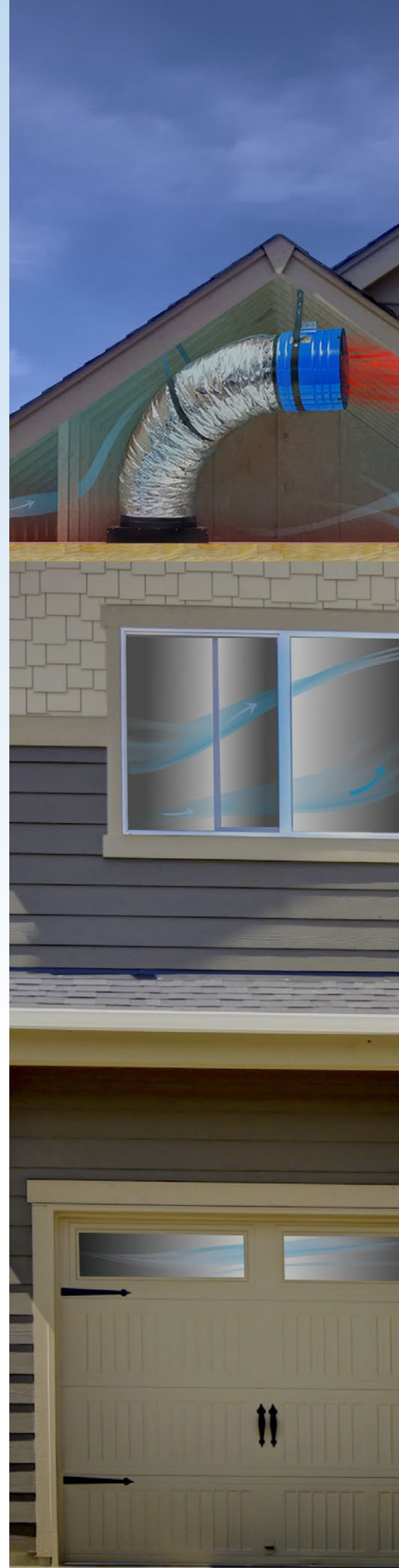



1. HOW TO USE YOUR QUIETCOOL

1.1 INTRODUCTION

CONGRATULATIONS

on the purchase of your new QuietCool Whole House Fan!

The QuietCool whole house fans dominate the market in energy efficiency and quietness. Whole house fans operate by pulling the cool air from outside your home, through the living space, into your attic, and out your attic vents. This accomplishes a cooling effect that can save you up to 90% off your A/C related energy costs depending on where you live. The difference between QuietCool and a standard whole house fan is a mix between its' astounding energy efficiency and its' jaw-dropping sound level. A standard whole house fan operates around 75dB; that's equivalent to a loud vacuum cleaner running!

The QuietCool system uses a cutting-edge, patented design to get our sound levels down to a respectable level. Our fans suspend in the attic and use an acoustical duct that connects to a ceiling box and grille. The result is an easy installation and quiet operation.

Once the air outside is cooler than the indoor air, crack open a few windows, turn your QuietCool on, and enjoy the hot air being sucked out of your home and pushed out of your attic with a nice, cool breeze. While performing 15-22 complete air exchanges per hour, the QuietCool whole house fan system will force the hot stale air out of the attic which will help your house stay cooler during the hotter hours of the next day!



1.2 FEATURES

- + Energy Efficient PSC Motor
- + Patented Design
- + Built in USA
- + R5 Insulated Dampers
- + 10 Year Warranty

1.3 WHEN TO RUN THE QUIETCOOL WHOLE HOUSE FAN

Anytime it is cooler outside than the inside of your home, the system will work effectively. In the summer this normally happens in the late afternoon to early evening, through to the next morning. We recommend running your fan through the evening. If you have a multi-speed fan, you will get the best cooling effect when you turn the fan on low after desired cooling occurs and let it run throughout the night.

1.4 WHERE TO START COOLING THE HOME

We recommend cooling the area where you are going to be spending the most time for the next few hours. For example, in most family situations, the early evening is spent in the kitchen or family room area. Assuming this to be true, this is where you would want to start the cooling process.

Begin opening a few windows in the area you are going to be spending your time and turn on all of your QuietCool fans at once, for maximum cooling. The cool outside air will immediately begin to create a breeze in the home making you instantly feel up to 10 °F cooler. Opening windows too wide or opening too many windows will lessen the cooling breeze you feel.

The breeze will flow through your home and make its way to each QuietCool you have in operation. As it gets later in the evening, and even cooler outside, you can begin to open windows in other rooms of your home, to prepare for bedtime. Then when it's time for bed, you should close all the windows in your main living space, but leave the windows in your occupied bedrooms open. This will provide each room with a cool breeze as long as desired.

Using the timer, you can automate your fan and have it turn off when you anticipate it being comfortable for sleeping. If you have a QuietCool installed in each bedroom as we recommend, you can enjoy the breeze and your privacy with your door closed.



1.5 HOW QUIETCOOL WORKS

- 1 Open a few windows anytime it's cooler outside than inside, typically in the morning and evening.
- 2 Turn your QuietCool fan on by setting the speed and timer.
- 3 QuietCool pulls in cool, fresh air from outside and expels hot, stale air out attic vents.
- 4 Your home has now been made cooler, healthier, and more comfortable.



1.6 INDOOR AIR QUALITY

You will want to ventilate your home on a very regular basis. Many studies, such as one from the Environmental Protection Agency, show that the air inside a home can be 2-5 times more polluted than the air outside, even in the smoggiest of cities. Your QuietCool system can greatly reduce this problem by bringing in fresh air and exhausting stale polluted air.

Even in the cold winter months, running your QuietCool for just a few minutes each day will allow you and your family to breathe happier and healthier.

1.7 USING QUIETCOOL DURING THE WINTER

During the winter, you can use the QuietCool to warm up your home during the warmer parts of the day. Usually this occurs mid-day.

By running the QuietCool during the warmer parts of the day in the winter, you can heat up the thermal mass in your home so your heater doesn't have to work as hard. This also allows you to purge your home of the old, stale air that accumulates in your home during the winter due to lack of opening windows.

If you have any trouble installing or operating your new QuietCool whole house fan, or for more tips on running the QuietCool, please visit our website www.QuietCoolSystems.com or call us at 951-325-6340 for support.

2. SYSTEM OVERVIEW

2.1 PRODUCT DIAGRAM

A. ADJUSTABLE HANGING STRAPS - Keyhole straps that allow you to adjust up or down without removing the screw so the fan can be hung in nearly every attic space.

B. DUCT CLASP - Duct clasp that helps secure the ducting to the Airtight Damper Box and Steel Housing without screws or tape.

C. HEAVY DUTY STEEL HOUSING - This is the cylinder that houses the motor. Comes in diameters of 14", 16", 18", 20", 22", and 24".

D. COMPUTER BALANCED FAN BLADES - High-performance fan blades that cut through the air in the most efficient and effective way possible.

E. HAND GUARD - Guard that protects from potential injury or fan obstruction.

F. HIGH-PERFORMANCE ACOUSTICAL DUCTING - Noise dampening technology with insulated ducting that is used to separate the Steel Housing from the living space.

G. AIRTIGHT DAMPER BOX - Damper Box with R5 insulated doors that prevent any heat transfer from the attic to the living area.

H. R5 DAMPER DOORS - R5 lined damper doors to prevent air movement between the home and attic.

I. HIGH AIRFLOW GRILLE - Aesthetically pleasing removable egg-crate ceiling grille.

J. DUCT COLLAR - The adjustable collar that helps seal and secure the Heavy Duty Steel Housing and the Airtight Damper Box with no air leakage.

K. ENERGY EFFICIENT PSC MOTOR - The Permanent Split Capacitor Motor is very energy efficient.

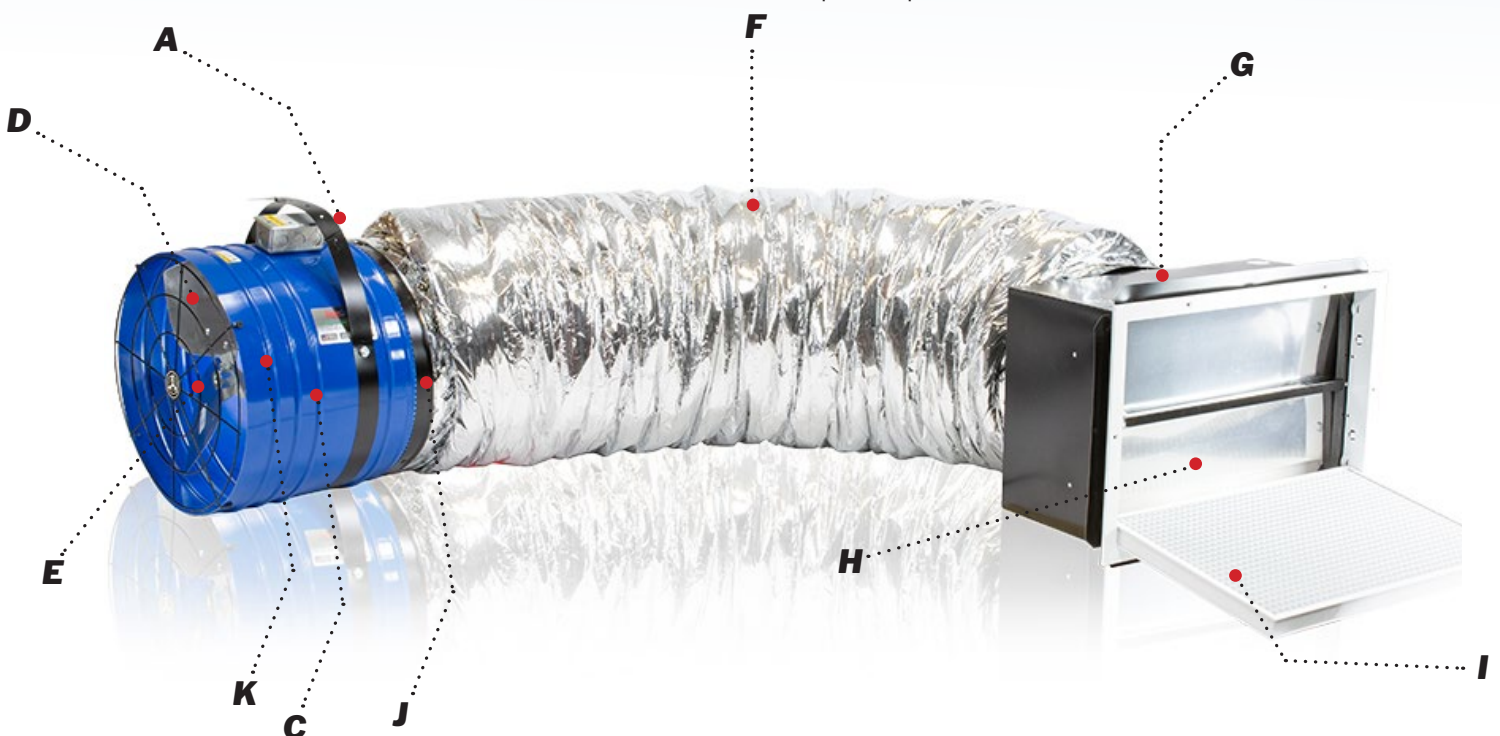







2.2 SYSTEM VENTING REQUIREMENTS

Ⓞ **VERY IMPORTANT:** 1 SQUARE FOOT OF NET FREE VENT AREA PER 750 CFM

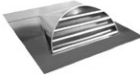
Ⓞ **RECOMMENDED:** 2 TO 4 SQUARE FEET OF INLET VENTS PER FAN

Venting plays a very significant role in the performance of QuietCool fans. QuietCool recommends a minimum of 1 SQ. FT. of venting for every 750 CFM in the QuietCool system. If an attic has at least 1:750 attic venting, the QuietCool system will operate efficiently and effectively. If an attic has less than 1:750 attic venting, the system may not operate as efficiently, or effectively, as it could with 1:750 attic venting. But don't worry, the system will still operate if there is not enough venting.

Insufficient venting is a very simple problem to fix. Roofing contractors can add extra venting to most homes simply and easily. The most common types of venting is shown in the chart below.

Vent Type	Model Type	Average Size	Venting Sq. Ft.
Gable vent		12" x 19.5"	1.20
Dormer Vent		14" x 8"	0.70
Eave Vent		4" 5" 6"	0.03 0.04 0.07
Ridge Vent		4' - 12'	0.125 per ft
Soffit Vent		16" x 4" 16" x 6" 16" x 8"	0.19 0.29 0.39
O'Hagin Vent		Low/Medium Profile Tapered Low Profile Low Profile Flat High Profile	0.5 0.6 0.68 0.68
Turbine Vent		8" 12" 14"	.35 .79 1.1

*Note: This table is only a guideline and is not a guarantee of venting capacity.

READ ALL INSTRUCTIONS IN THIS GUIDE BEFORE INSTALLING YOUR QUIETCOOL GETTING STARTED

ⓘ **STOP!** Read the following pages before proceeding! The manufacturer is NOT responsible for faulty installation or product damages caused through failure to fully read this guide BEFORE attempting installation.

GENERAL SAFETY INFORMATION

- 1. READ INSTRUCTIONS** - All safety and operation instructions must be read.
- 2. RETAIN INSTRUCTIONS** - The safety and operating instructions should be kept for future reference.
- 3. HEED WARNINGS** - All warnings should be followed.
- 4. FOLLOW INSTRUCTIONS** - All installation and operating instructions should be followed.
- 5. WATER** - The QuietCool system should not be used near water. If you live in a very humid climate, be sure to cover your damper box with insulation to reduce condensation.
- 6. HEAT** - The QuietCool system should be situated away from heat sources.
- 7. DAMAGE REQUIRING SERVICE** - Only qualified service personnel should service the QuietCool system. The user should not attempt to service the product.
- 8. AVOID BACKDRAFTS** - Care should be taken to avoid backdrafting combustion appliances that are installed in the conditioned space. Whole house fans are capable of pulling large quantities of air, from the home, particularly if not enough windows are open. This could easily backdraft gas appliances located inside your home. Take care if you have gas appliances installed inside of your home.

WARNINGS

- ⓘ **CAUTION:** This unit has an unguarded impeller. Do not use in locations readily accessible to people or animals.
- ⓘ **CAUTION:** Do not operate any fan with a damaged cord or plug. Discard fan or return to an authorized service facility for examination and/or repair.
- ⓘ **CAUTION:** Do not run cord under carpeting. Do not cover cord with throw rugs, runners, or similar coverings. Do not route cord under furniture or appliances. Arrange cord away from traffic area and where it will not be tripped over.

TEMPLATE SIZES

The template size varies depending on which model of QuietCool fan you are installing:

QuietCool Fan Model	Template Size	Vertical Adapter Model (Sold Separately)
QC CL-1500	14-1/4" x 14-1/4"	VA-1414
QC CL-2250	14-1/4" x 18-1/4"	VA-1418
QC CL-3100	14-1/4" x 22-1/4"	VA-1422
QC CL-4700 & QC CL-5400	14-1/4" x 30-1/4"	VA-1430
QC CL-6000 & QC CL-7000	14-1/4" x 36-1/4"	VA-1436

SPECIAL INSTRUCTIONS

1. CHECK the box when opening for the first time; loose parts may shift during shipping. Check box contents against the section "Included in the Box" before proceeding with installation. Do NOT throw away the shipping box until completely satisfied with the product.

Note: Included controls will be located at the bottom of the box.

2. BEFORE CUTTING into ceiling drywall, "measure twice, cut once." This ensures that you don't make mistakes in either selecting the wrong location for the intake grille, or cutting the wrong size hole.
3. READ wiring instructions BEFORE attempting to wire the product. Product warranty does NOT cover defective motors resulting from wiring errors.
4. DO NOT use any QuietCool ducted whole house fan in a home with all closed windows.
5. TEST your QuietCool unit before installation using the included power cord. If the fan does not work, call us immediately.

SPECIAL INSTRUCTIONS TO CONTRACTORS

1. DO NOT take the Owner's Guide with you after the installation. This Owner's Guide has the serial number and warranty information of the homeowner's product.
2. DEMONSTRATE the use of the product to the customer before leaving the home, INCLUDING; explain the use of the timer, switch, and/or smart application as applicable.
3. PROVIDE the customer with a completed invoice that clearly shows your company name, product model # and product serial number, date of sale and installation, and price paid. The manufacturer is not liable for warranty claims where proof of purchase cannot be verified.

SPECIAL INSTRUCTIONS TO DO-IT-YOURSELFERS

1. DO NOT attempt to install any QuietCool cooling and ventilation system yourself if you lack sufficient skill and experience to do so.
2. WATCH the installation videos on the manufacturer website by visiting www.QuietCoolSystems.com/support or by scanning any QR code found in this guide that appears next to any instructional step.

INCLUDED IN THE BOX

- QuietCool Whole House Fan
- QuietCool Damper Box
- QuietCool Duct
- Ceiling Grille
- Hardware Kit
- Nylon Strap
- Cut-out Template

HARDWARE KIT CONTENTS

- A. (9) All-Purpose Screws
 4 for Hanging Strap
 4 for Damper Box to Drywall
 1 extra
- B. (6) Pan Head Screws
 4 for Duct Strap
 2 extra
- C. (2) Window Locks



TOOLS YOU WILL NEED

- Cordless Drill with Nut Driver and Philips Bit
- Drywall Saw
- Measuring Tape
- Carpenter Pencil

3. INSTALLATION

3.1 INSTALLING CLASSIC WHF

Installation Video:

Watch the video by scanning the QR code or visit www.QuietCoolSystems.com/support



Installing the QuietCool system is very easy. Simply follow the steps given below:

Determine from down below in which areas you would like to install your QuietCool fan. Go up into the attic to mark the exact location for the fan. Make sure you have a minimum of 30" of clearance. Take the cardboard cutout template and a small screwdriver with you. Make sure the template fits between the framing.

Figure 3.1A



Figure 3.1B



Figure 3.1C



Figure 3.1D

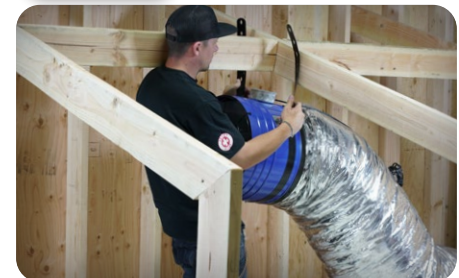

1. When you have chosen your exact spot, place the provided template on the spot and mark it at each corner by pushing the screwdriver through at each corner to make a hole so that you can find it from below.
2. From below, place the cut-out template on the ceiling, making sure that you have at least 2 inches of clearance all around it. While holding the template in place, mark its outline with a pencil.
3. Using a drywall saw or similar device, cut out the hole in the ceiling.
4. Open and unpack your QuietCool fan.

ⓘ TIP: If your attic is very tight, you may want to wire your QuietCool motor housing before bringing it into the attic. Please follow the wiring diagrams that start on page 13.

5. Take the main assembly, which includes the motor housing, damper box, and duct into the attic through the crawl hole and move into position near the ceiling cut-out hole.

ⓘ TIP: If your attic access is far from your fan location, you can remove the duct from the motor housing and pass the motor housing, duct, and damper box through the ceiling cut out hole and reattach the duct to the motor housing in the attic.

6. Pre-screw two of the included All-Purpose screws into the rafter almost all the way. Using the hanger strap with eyelet holes, hang the motor head from the two wood screws and tighten the screws. Make sure that the handy box on the motor head is at the very top. Secure duct to damper box using the duct clasp. Make sure the housing is angled slightly up and the duct has a gentle 90 degree bend to help reduce noise level. The angle is important so the fan does not disturb any blown-in insulation in your attic.

① **NOTE:** Once your QuietCool fan is hung, it's time to go below and install the damper box and ceiling grille.

① **NOTE:** If you are installing the damper box with a vertical adapter, please follow the instructions on page 12.

7. Look through the hole and make sure there are no kinks or twists in the ducting. Pull the damper box down through the hole in the ceiling.

① **NOTE:** The QuietCool Damper Box includes removable flanges in the case that you are installing the damper box between studs that are exactly 16" on center. To remove the flanges, simply take a screwdriver and pry between the flange surface and the damper box. Do this along the entire edge of the flange and it will pop off.

① **NOTE:** The damper box flange is designed to sit on the backside of the drywall, inside the attic. Do not attempt to install the damper box with the flanges on the outer side of the drywall in the home.

Figure 3.1E



8. Using 4 of the included All-Purpose screws, fasten the damper box to both the drywall and the joist in the attic.

① **NOTE:** Remember that you must fasten the damper box to the ceiling joists AND drywall. The purpose of this is to make sure the damper box stays in place when you are screwing in the grille. If you do not fasten the damper box to the drywall, the damper box will not stay in place when attempting to screw in the grille.

Figure 3.1F



9. Remove ceiling grille and screws from its packaging. Center the grille over the damper box. Install the grille with the white screws provided by screwing through the drywall into the flange of the damper box.
10. Return to the attic. Using the nylon straps and the Pan Head screws provided, support the duct to the framing. This will stabilize the entire assembly. Replace any insulation that was removed. The installation of the fan is now complete.

① **NOTE:** Do not install the QuietCool grille over a staircase, to prevent any risks during grille maintenance.

① **NOTE:** Some ceiling surfaces are uneven and may cause a small gap to be present. This can easily be caulked later if excessive.

① **NOTE:** Local building codes and standards must be adhered to in the installation of this unit.

① **NOTE:** Additional insulation can be added to the top of the damper box to provide additional sound dampening.

① **NOTE FOR BUILDERS:** When installing prior to sheetrock, the flange should be removed on all four edges, for both 24" and 16" on center to facilitate damper box exchange without damaging sheetrock. Damper box should be screwed to the bottom joists from inside the damper box, away from the doors and grille insert areas.

3.2 INSTALLING VERTICAL ADAPTER

A vertical wall adapter allows a damper box to be installed in the wall instead of the ceiling. A vertical adapter is installed on the wall with the damper box mounted diagonally so the damper doors close properly when the fan is turned off.

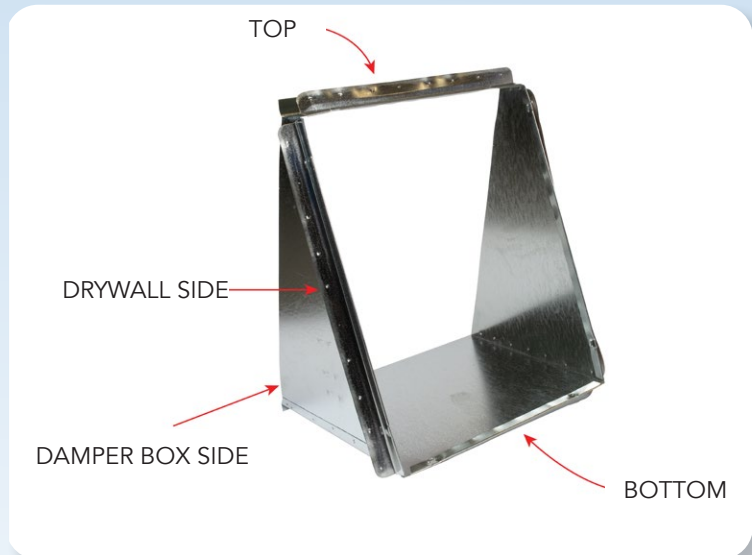
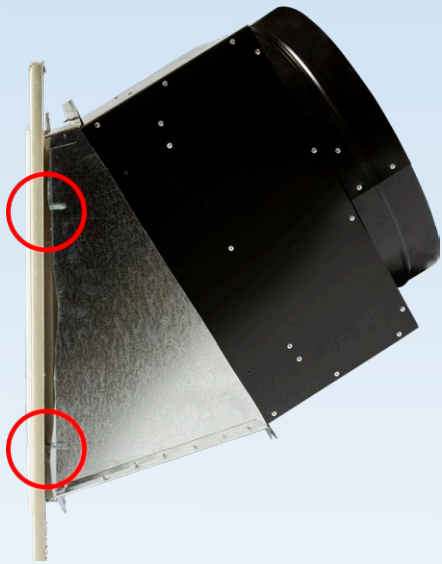

- Ⓢ **NOTE:** Measure the studs in your wall. If they are 16" on center, you will need to follow steps 1 through 4 completely. If they are wider than 16" on center, you will only need to follow steps 1 & 4.
- Ⓢ **NOTE:** The damper box **MUST** be installed with the damper doors oriented vertically. If the damper box is mounted on the wall with the damper doors horizontally, the damper doors will not operate correctly.

1. Note the T (TOP) side of the vertical adapter. Place the vertical adapter with the T side up onto the damper box with the side that has only two flanges, flush on the damper box.

2. If you have studs spaced at 16" on center, you will need to remove certain flanges on the damper box and vertical adapter. Using a flat head screwdriver, remove the two side flanges on the vertical adapter. (See Figure 3.2A)

Figure 3.2A



Figure 3.2B



3. Using a flat head screwdriver, remove the two side flanges on the damper box. Make sure that you are removing the flanges on the same side as the flanges you removed on the vertical adapter. (See Figure 3.2B)

4. Using the included black sharp screws, attach the vertical adapter to the damper box by screwing them together through the two remaining flanges.

5. The vertical adapter is now installed. Go back to step 8 on page 10 and continue your installation.

4. WIRING AND CONTROLS

ⓘ **IMPORTANT:** Wiring Diagrams are for examples ONLY. Wiring should be done by a licensed electrician following local building and electrical codes and/or NEC guidelines.

ⓘ **NOTE FOR NEW CONSTRUCTION:** Where use of arc-fault breakers are 100% implemented in the home, or if the whole house fan is installed in a wet area such as a bathroom, wiring a dedicated circuit may be required.

ⓘ **NOTE:** Your fan came pre-wired to a power cord for testing purposes before installation. If you would like to hard-wire the fan, or it is required by your local building codes, please follow the wiring instructions below.

4.1 SINGLE SPEED WIRING (FOR QC CL-1500)

1. For this installation, you will need (2) 2 wire Romex, and an 8 Hour Timer. Using the included wire nuts, tie the black wire from the first 2 wire Romex from the power source to the black wire on the timer. (see Figure 4.1A)
2. Using a wire nut, tie the black wire on the 2 wire Romex from the fan to the red wire on the timer.
3. Using a wire nut, tie the bare copper wires together with the green ground wire on the timer.
4. Using a wire nut, tie the white neutral wires from the Romex to the white neutral wire on the timer.

Figure 4.1A

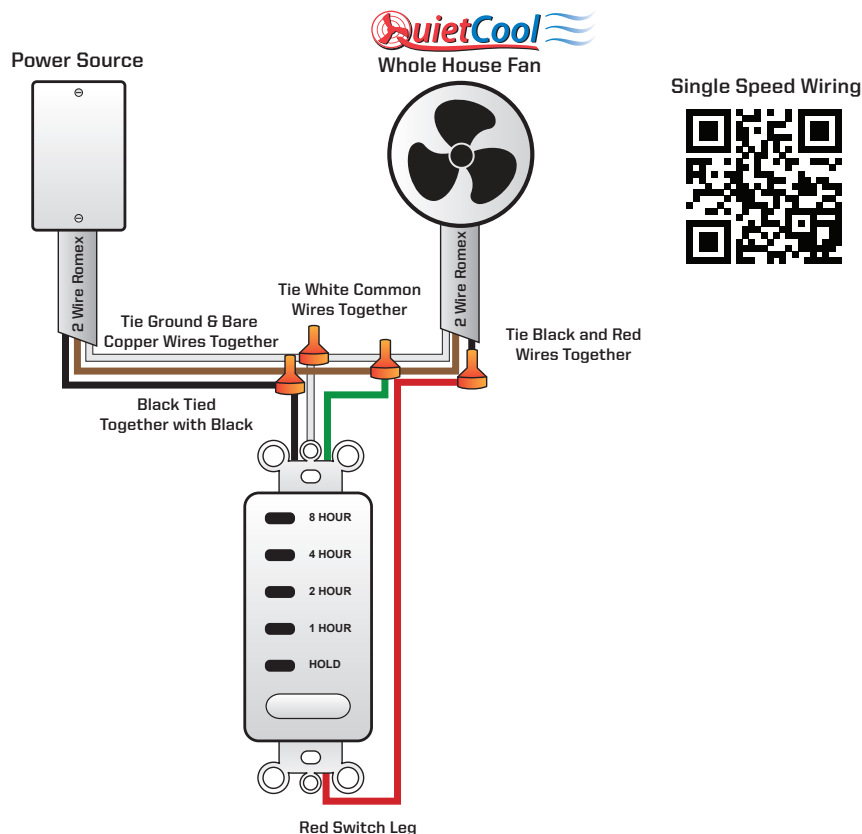
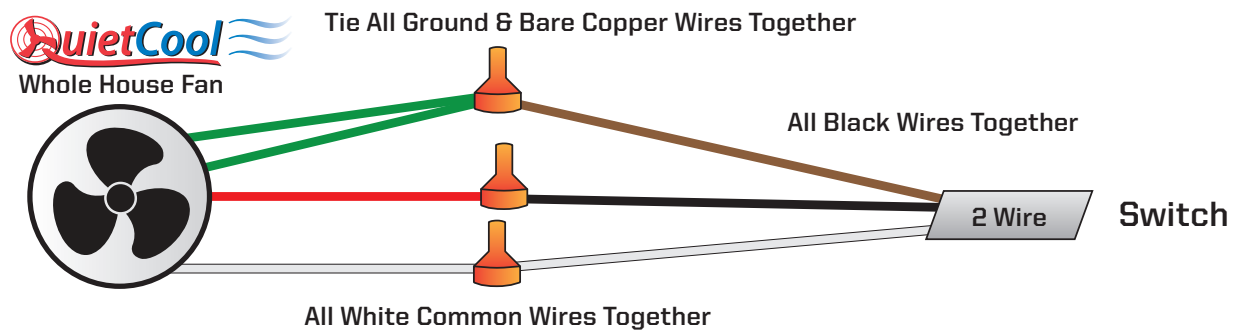

Figure 4.1B



5. Begin wiring the fan by opening up the handy box.
6. Take off the wire nuts within the handy box.
7. Unscrew the green ground wire. Detach the green ground wire from the power cord. Remove the power cord and strain relief connector.
8. Re-attach the ground screw and wire to the handy box. Cut your green ground wire in half and strip both sides. (see Figure 4.1B)
9. Install the included romex connector in the junction box and feed the 2 wire Romex through the handy box.
10. Using the included wire nuts, tie the black wire and red wire together.
11. Tie the white neutral wires together.
12. Tie your bare copper wire and green ground wires together.
13. Carefully reinstall the handy box cover.

4.2 TWO SPEED WIRING (FOR QC CL-2250/3100/4700/5400/6000/7000)

1. For this installation, you will need a 2 and 3 wire Romex, an 8 Hour Timer, and a HIGH-LOW-OFF Switch. Using the 3 wire Romex, attach the black wire to the bottom gold screw on the right of the switch for high speed and attach the red wire to the top gold screw on the right for low speed. (see Figure 4.2A)
2. With a piece of bare copper wire, attach it to the green ground screw on the switch. Using a wire nut, tie all bare copper wires together with the green ground wire on the timer.
3. Using the included wire nuts, tie the black wire from the 2 wire power source to the black wire on the timer. Tie the white neutral wire from the 2 wire power source to the white neutral wire on the timer and the white neutral wire from the fan.
4. Attach the red leg wire from the timer to the gold screw on the right of the switch. Install the switches and switch plate cover.

Figure 4.2A

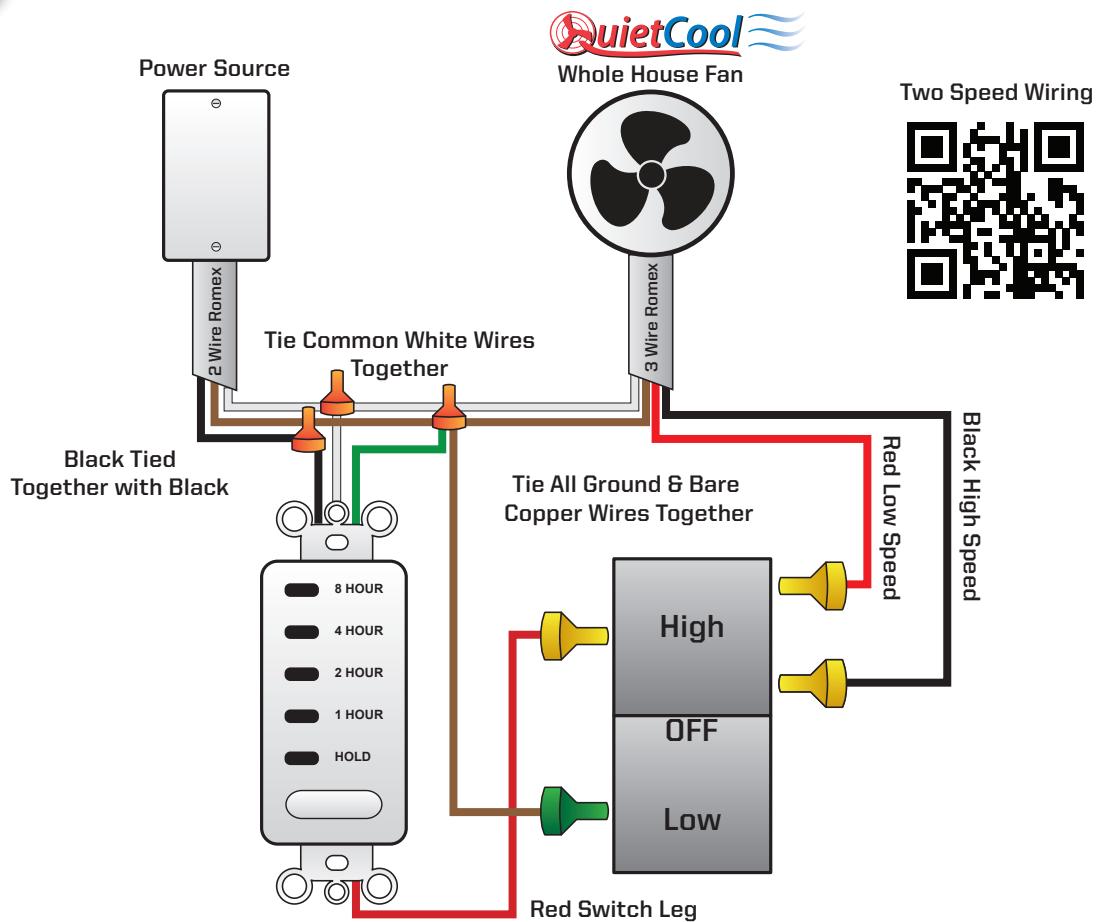
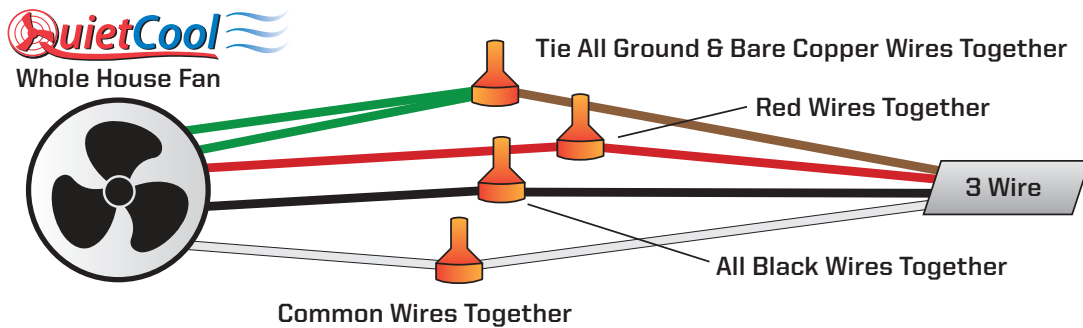

Figure 4.2B



5. Begin wiring the fan by opening up the handy box.
6. Take off the wire nuts within the handy box. Unscrew the green ground wire from the handy box.
7. Detach the green ground wire from the power cord. Remove the power cord and strain relief connector.
8. Re-attach the ground screw and wire to the handy box. Cut your green ground wire in half and strip both sides. (see Figure D)
9. Install the included romex connector in the junction box and feed the 3 wire Romex through the handy box.
10. Using the included wire nuts, tie the black wires together for high speed.
11. Tie the red wires together for low speed.
12. Tie the remaining white neutral wires together.
13. Tie your bare copper wires and green ground wires together.
14. Carefully reinstall the handy box cover.

5. SYSTEM OPERATING INSTRUCTIONS

5.1 OPERATING THE WALL CONTROLS

SINGLE SPEED CONTROLS (TIMER ONLY)

- The 8 Hour Countdown Timer is a convenient way to control your QuietCool fan.
- By clicking the button on the timer, you can cycle through the timer options.
- The last cycle of the timer turns the fan off. All lights will be off when the fan is off.
- By holding the button on the timer, the timer will enter HOLD which will keep the fan on indefinitely.
- This only controls single speed QuietCool fans, or multi-speed QuietCool fans on one single speed.

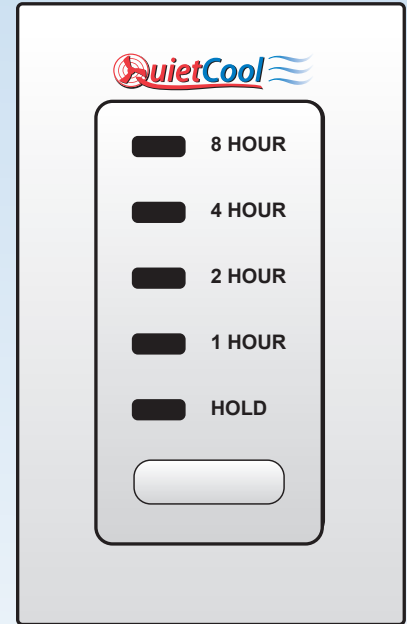

TWO SPEED CONTROLS (TIMER + HIGH-LOW-OFF SWITCH)

- To control a multi-speed QuietCool fan, we recommend the 8 Hour Countdown Timer and a HIGH-LOW-OFF Switch.
- By clicking the button on the timer, you can cycle through the timer options.
- The last cycle of the timer turns the fan off. All lights will be off when the fan is off.
- By holding the button on the timer, the timer will enter HOLD which will keep the fan on indefinitely.
- When the HIGH-LOW-OFF Switch is in the middle position, the fan will be off, regardless of the setting on the Timer.
- With the switch in the top position, the fan will be on HIGH.
- With the switch in the bottom position, the fan will be on LOW.

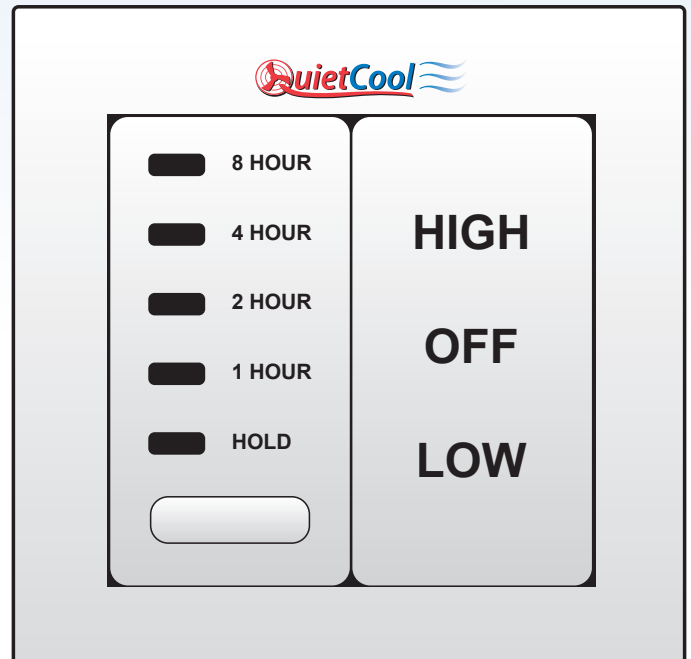

WHOLE HOUSE FANS LIMITED WARRANTY

This warranty is extended to the original purchaser of this model or, if this unit is purchased and requires installation by a building contractor, to the original owner of the home. No subsequent purchaser of the unit or of a home in which it is installed is entitled to any of the benefits of this warranty. The QuietCool Product that you have purchased has a limited warranty from the date of purchase against defects in workmanship and materials. Please see attached chart below for warranty details. If you believe you received a defective product, call our customer service at 1-888-QUIETCOOL. Have proof of purchase available to validate the warranty. If it's necessary to send the defective part to QC Manufacturing, Inc., freight is paid by the customer. If found to be defective following examinations, any defective part will be replaced free of charge and returned freight prepaid. This warranty does not cover any labor costs, including those required for diagnosis, field repair or replacement or removal of any allegedly defective part. The company reserves the right to require and receive proof of purchase of the date of purchase before undertaking its obligations under this warranty. The right to require and receive proof of purchase of date of purchase extends to all licensed dealers of QC Manufacturing Inc. products.

Limitations

QC Manufacturing, Inc. shall not be liable for, and this warranty does not apply to, any failure, defect or damage resulting from or connected with misuse, abuse, neglect or improper handling or staging, or installation not in strict adherence to QC Manufacturing's written instructions; unauthorized alteration to factory specs, lack of maintenance, lack of proper ventilation transportation damage, impact of foreign objects, fire, flood, earthquake, lightning, hurricane, hail, tornado or other violent storms, force majeure or other act of (g)God; or defects in failure of or damage caused by materials used as roofing base over which the product is installed or by movement, distortion, cracking or settling of walls or the foundation of the building. QC Manufacturing, Inc. reserves the right to discontinue or modify any of its products including, without limitation, color, and shall not be liable as a result of such discontinuation or modification, nor shall QC Manufacturing, Inc. be liable in the event replacement material may vary in color in comparison to the original product as a result of normal weathering.

Even if your Fan was not properly installed according to QC's published application instructions, this limited warranty remains in effect if your Fan fails to perform as a result of a manufacturing defect.

However, QC will NOT compensate you for:

1. Damage from anything other than an inherent manufacturing defect in your Fan, such as:
 - Improper installation of your Fan, faulty application, or application not in strict accordance with QC's published application instructions.
 - Settlement, movement, or defects in the building, walls, foundation, roof deck, or materials adjacent to or over which the Fan was installed.
 - Improper storage or handling of your Fan.
2. Damage resulting from the application of overlying or adjacent roofing materials.
3. Damage resulting from mold growth or condensation.
4. Chipping, fading, or peeling paint on your Fan.
5. Labor costs for removing or replacing your Fan except as specifically provided for above or for any other roofing or building materials.

Limited Warranty Protection

Whole House Fans - Controls

QC Manufacturing, Inc. extends this warranty coverage to the original purchaser of the following QuietCool products (see attached for applicable products) for a period of time (varies by product) provided that the product has been installed in strict accordance with QC Manufacturing, Inc.'s written installation instructions. Under this warranty, QC Manufacturing, Inc., at no charge, will repair or replace any product found to be defective during the warranty period as long as proof of purchase is submitted to QC Manufacturing, Inc. (QC Manufacturing, Inc.'s period begins when the product installation is completed). QC Manufacturing, Inc.'s maximum liability under this limited warranty will be equal to the reasonable cost to replace the defective product.

WHOLE HOUSE FANS LIMITED WARRANTY

Motor Replacements

The electrical motor is to be used solely as a direct replacement for a motor of the same model in QC Manufacturing, Inc., QuietCool products. Using the motor in any other product could result in electrical shock and/or fire, which may cause property damage, serious injury or even death. Any motor replacement should be installed by a qualified licensed electrician in accordance with local, state and national electrical codes and standards. Make sure that power to the unit has been completely turned OFF at the breaker before approaching or inspecting or installing the replacement motor. If found that the motor failure was by improper installation QC will not be liable for any cost associated with the motor replacement. For example, cost of motor and shipping costs to and from the customer. Repairs and replacement parts supplied under this warranty are warranted only for the period listed in the below chart from the date of original retail purchase of the unit.

Other Conditions

This warranty is the entire agreement between you and QC Manufacturing, Inc., and there are no other oral or written warranties, liabilities or obligations of QC Manufacturing except apart from those set forth herein. Pertinent state law shall control for what period of time subsequent to sale a consumer/homeowner may seek a remedy pursuant to the implied warranty of merchantability or fitness for a particular purpose. In no event shall QC Manufacturing, Inc. be liable for consequential or incidental damages of any kind, including any damage to the building, its contents or any persons therein, resulting from the breach of any warranty set forth herein, unless exclusion of these types of damages are specifically prohibited by state law. No field representative of QC Manufacturing, Inc. or any distributor or dealer is authorized to make any change or modifications to this warranty.

Whole House Fan Products	Model Numbers	Warranty
Classic Models	QC CL-1500, QC CL-2250, QC CL-3100, QC CL-4700, QC CL-5400, QC CL-6000, QC CL-7000	Ten (10) Year coverage applies to the QuietCool motor fan assembly. Which includes Motor and Fan Blade.
Energy Saver Models	QC ES-1500, QC ES-2250, QC ES-3100, QC ES-4700, QC ES-5400, QC ES-6000, QC ES-7000	One (1) Year coverage for all other components including grilles, housings, damper boxes, ducts, controls and accessories furnished by QC Manufacturing, Inc.
Accessories	Model Numbers	Warranty
Controls	IT-RFHUB-01, IT-RFSWITCH-01, IT-30070, IT-30045, IT-35000	One (1) Year coverage applies to the models indicated.

How to Start the Warranty Process

To obtain service under this warranty, first contact your dealer where you purchased the equipment. If you are unable to find or reach your dealer, contact Customer Service at QC Manufacturing, Inc. by phone, email or visiting our website at <https://quietcoolsystems.com/support/return-merchandise-authorization/> to start the RMA process.

An RMA (Return Merchandise Authorization) form is required for returns to the factory to ensure your return can be processed efficiently and quickly. There is no informal dispute settling mechanism available in the event of a controversy involving this warranty

QC Manufacturing, Inc. Customer Service

26040 Ynez Rd.
Temecula, CA 92591
www.QuietCoolSystems.com
951-325-6340

Rev. 9/29/22



FAN SERIAL NUMBER INFORMATION



RETAIN FOR YOUR RECORDS.

SERIAL NUMBER IS REQUIRED FOR WARRANTY PURPOSES.